

The logo for BEWA, featuring the word "BEWA" in a stylized, italicized font with a registered trademark symbol (®) to the upper right. The logo is white and is set against a solid red square background.

PREFABRICATED  
CONCRETE SYSTEMS



# Prefabricated Shelters

## BEWA beton.

Peace of mind for you and your family.

BEWA beton Sp. z o.o.  
Wiechlice, ul. Przemysłowa 16  
67-300 Szprotawa, Poland

tel. +48 68 376 77 33  
bewa@bewa.com.pl  
www.bewa.com.pl





### YOUR SAFE AND COMFORTABLE SHELTER

Life is unpredictable, but you can be ready for any situation. **The Safe 3, Safe 4 and Safe 6** prefabricated backyard shelters are solutions designed for your safety and comfort. We designed each model for reliable protection in difficult moments and to function as a comfortable everyday space.

### A FUNCTIONAL KITCHEN FOR EVERY SCENARIO

The kitchen area in our shelters has been designed to optimise the available space. The frame construction has enough space for a fully functional cooking area with an induction stove, a sink and other necessary elements. The durable worktop has 4 height-adjustable cupboards with drawers that guarantee comfort and functionality. The shelf above the worktop has an aluminium flap to keep your most important things within reach.

### COMFORTABLE SLEEPING AREA

The well-thought-out design of the sleeping area allows for maximum flexibility and comfort. The frame system lets you build up to four beds, with the upper beds folding down to turn the space into comfortable seating for everyday use. The shelves under the seating area have space for bedding, and the foldable table allows you to eat or work comfortably. A separate sleeping compartment with a soundproof sliding door guarantees silence and privacy.

### TAILORED TO YOUR NEEDS

Each of our models - **Safe 3, Safe 4 and Safe 6** - are tailored to house different numbers of users with enough space to meet your expectations. Constructed from the highest quality materials, including lightweight plastics with a layer of aluminium honeycomb, our safes have extended durability, thermal insulation and a modern design.

**Don't wait for a crisis to happen** - invest in a solution that will give you a sense of security and comfort, no matter the circumstances. A safe shelter is not just about protection, it is also about functionality and convenience, ensuring that you are prepared for any eventuality.



**BEWA**

**PREFABRICATED  
CONCRETE SYSTEMS**

BEWA beton Sp. z o.o.  
Wiechlice, ul. Przemysłowa 16  
67-300 Szprotawa, Poland

tel. +48 68 376 77 33  
bewa@bewa.com.pl

**CHECK OUT OUR OFFER**  
[www.bewa.com.pl](http://www.bewa.com.pl)

# Advantages of prefabricated backyard shelters **BEWA beton.**

## 01. SAFETY AND PROTECTION IN ALL SITUATIONS

Make sure you and your family have a shelter so you can be well-prepared for natural disasters, armed conflicts or other threats. A prefabricated bunker gives you peace of mind in difficult times. You can also confidently protect your loved ones in any situation that requires quick action.

## 02. SUSTAINABILITY AND DURABILITY

Our shelters are made from the highest quality materials, resistant to shock, fire and extreme weather conditions. Our high-precision manufacturing technology ensures that every bunker is reliable, especially in the most critical moments. You will be making a rewarding investment that will survive any challenge, for years to come.

## 03. CUSTOMISED TO YOUR NEEDS

The size and fittings of each shelter can be customised to your family's needs. From a temporary emergency shelter to a fully equipped bunker for long-term survival, we have you covered. Our state-of-the-art solutions guarantee maximum comfort and functionality.

## 04. PROPERTY VALUE INCREASE

A backyard shelter not only provides security, but also adds value to your property. Our innovative bunkers can be an asset if you decide to sell your property. Compared to other properties, the bunkers can increase interest and create a sense of unique investment for buyers.



**BEWA**

**PREFABRICATED  
CONCRETE SYSTEMS**

BEWA beton Sp. z o.o.  
Wiechlice, ul. Przemysłowa 16  
67-300 Szprotawa, Poland

tel. +48 68 376 77 33  
bewa@bewa.com.pl

**CHECK OUT OUR OFFER**  
[www.bewa.com.pl](http://www.bewa.com.pl)

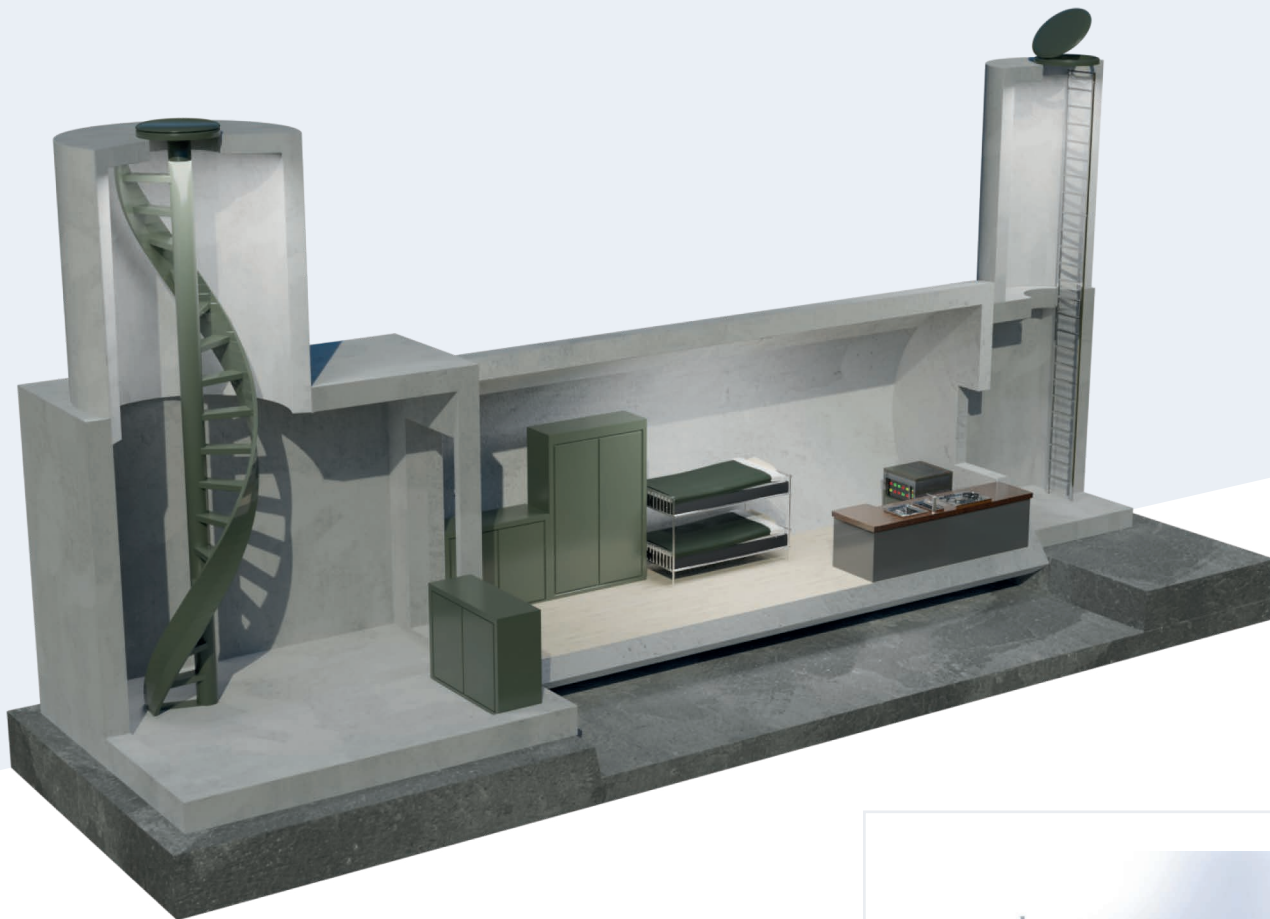

## STAY SAFE IN ANY SITUATION

Our shelters are a combination of modern solutions, robust construction, and critical details that ensure your safety and comfort. The well-thought-out interior layout includes both bedroom and kitchen space, making the shelter a fully functional and livable place to stay in an emergency.



**BEWA**

**PREFABRICATED  
CONCRETE SYSTEMS**

BEWA beton Sp. z o.o.  
Wiechlice, ul. Przemysłowa 16  
67-300 Szprotawa, Poland

tel. +48 68 376 77 33  
bewa@bewa.com.pl

**CHECK OUT OUR OFFER**  
[www.bewa.com.pl](http://www.bewa.com.pl)

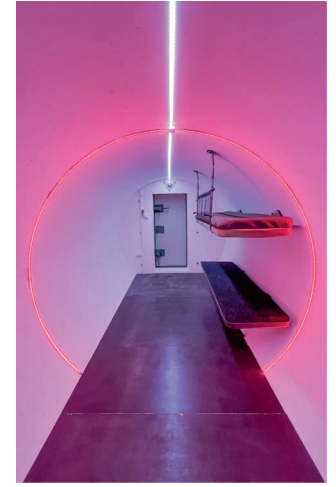
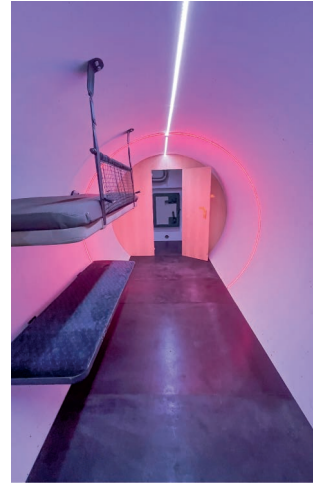

	Shelter <b>SAFE 3</b>	Shelter <b>SAFE 4</b>	Shelter <b>SAFE 6</b>
Length	10650 mm	10650 mm	10450 mm
Width (external)	2900 mm	3700 mm	5000 mm
Width (internal)	2500 mm	3200 mm	4600 mm
Height	4900 mm	5700 mm	4700 mm
Concrete class	C35/45	C35/45	C35/45
Weight	55,67 T	73,63 T	78,91 T
Volume	23,69 m <sup>3</sup>	31,33 m <sup>3</sup>	33,58 m <sup>3</sup>
Surface	18,5 m <sup>2</sup>	22,28 m <sup>2</sup>	32,89 m <sup>2</sup>
	Possibility of extending the shelter with additional modules.	Possibility of extending the shelter with additional modules.	Possibility of extending the shelter with additional modules.



**PREFABRICATED  
CONCRETE SYSTEMS**

BEWA beton Sp. z o.o.  
Wiechlice, ul. Przemysłowa 16  
67-300 Szprotawa, Poland

tel. +48 68 376 77 33  
bewa@bewa.com.pl





# Shelter **SAFE 4**

TECHNICAL SECTION WITH DIMENSIONS

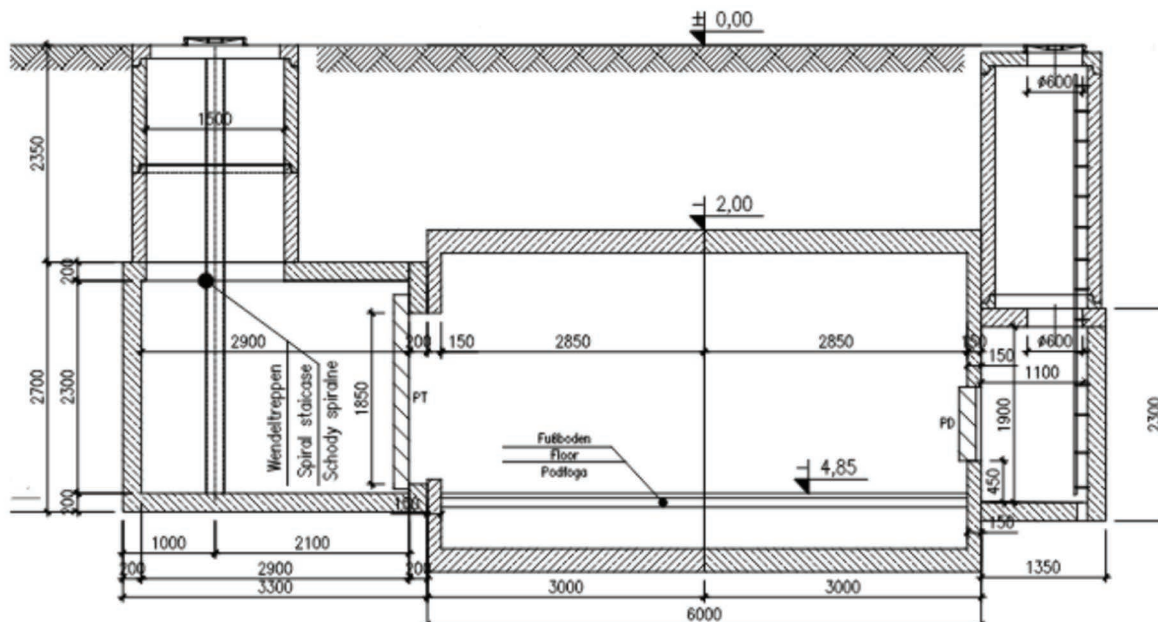

## SAFE 4 SHELTER - MORE SPACE, MORE OPTIONS

The Safe 4 model is ideal if you need more space and functionality. The precise dimensions and well-thought-out design feel comfortable to use, both in everyday life and emergency situations.

## MODERN TECHNICAL SOLUTIONS

The Safe 4 shelter is designed with long-term use in mind. High-grade materials, optimum dimensions and a spacious interior guarantee reliability and comfort, while allowing the internal fittings to be easily personalised according to your needs.

**BWA**

PREFABRICATED  
CONCRETE SYSTEMS

BEWA beton Sp. z o.o.  
Wiechlice, ul. Przemysłowa 16  
67-300 Szprotawa, Poland

tel. +48 68 376 77 33  
bewa@bewa.com.pl

CHECK OUT OUR OFFER  
[www.bewa.com.pl](http://www.bewa.com.pl)



# Prefabricated backyard shelters - BEWA beton.

Our shelters are equipped with top-of-the-range doors and technical systems that guarantee maximum safety and reliability. They are precisely designed as anti-burglary and explosion-proof doors that form a solid barrier, so you have extra protection from external threats. Their special design and high-quality materials, such as reinforced steel, meet the most stringent safety standards.

Internal ventilation and filtration systems are key components that ensure a constant supply of fresh air even in the most extreme conditions. Our innovative solutions ensure effective removal of used air, filtering of pollutants, and protection against chemical and biological substances.

The diagrams show detailed technical solutions, including the layout of the fitting system, the location of the critical components and the structural sections of the doors. Since precision and functionality are our top priorities, we make sure every part and detail always satisfies its purpose.

**Our technologies are a guarantee of protection - under all circumstances.**

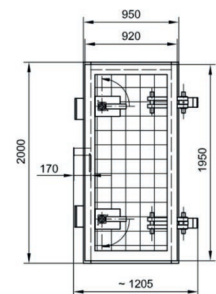
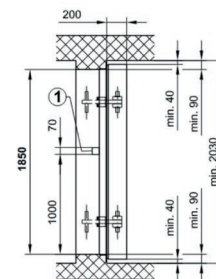

ENTRANCE DOOR

TECHNICAL INSTALLATIONS

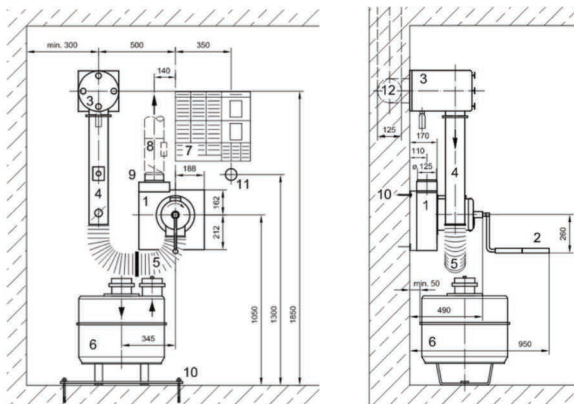

PREFABRICATED  
CONCRETE SYSTEMS

BEWA beton Sp. z o.o.  
Wielichce, ul. Przemysłowa 16  
67-300 Szprotawa, Poland

tel. +48 68 376 77 33  
bewa@bewa.com.pl

CHECK OUT OUR OFFER  
[www.bewa.com.pl](http://www.bewa.com.pl)

# Sleeping area

## Comfort and functionality of the bedroom space

The bedroom area of the bunker is designed with comfort and efficient use of space in mind. The modular design allows for flexible configuration, so you can have space for sleeping, storage and daytime relaxation.

High-quality materials and thoughtful solutions mean that the shelter bedroom combines practicality with comfort. For instance, the folding beds allow the space to be quickly transformed into a comfortable seating area. The under-seat drawers offer additional storage options. Also, a separate sleeping area with soundproof doors ensures privacy and tranquillity at all times.

### Bedroom area

- Frame construction with space for four beds
- The foldable upper bed can be used as a comfortable seat or a place to spend time during the day
- The bed boards are made from a special lightweight plastic with an inner layer of aluminium honeycomb, which gives it high rigidity and thermal insulation
- The lower part of the seat has 2 drawers
- A larger lower drawer where bedding (for example) can be stored
- Upper drawer with space for a folding table
- A sliding door separates the sleeping area from the rest of the room; and it is also made from soundproof plastic

## Underfloor module

- The bedroom section consists of 2 modules
- Each underfloor module has a raised floor made of non-slip plywood
- There are four drawers inside the module mounted on ball-bearing slides with a load capacity of up to 40 kg
- Modular construction with configuration of underfloor space

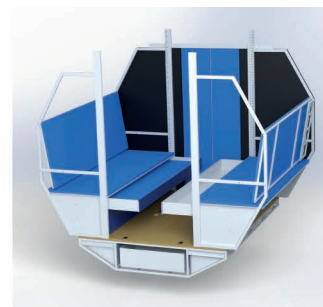
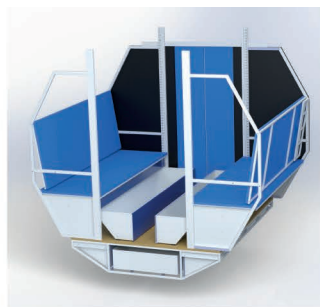
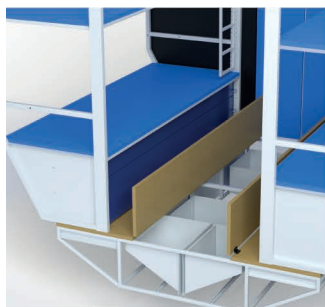

# Kitchen area

## Practical and convenient kitchen space

The kitchen area of the shelter is a functional solution where you can prepare meals comfortably. With the modular design, you can build a full kitchenette, complete with cupboards, a worktop and space for appliances such as an induction hob or sink. This shelter is a practical and sustainable solution adapted to everyday needs and emergencies.

High-quality materials ensure durability and a well-thought-out layout gives you access to all necessary elements. In addition, with a functional shelf above the worktop, you can easily store essential products within easy reach.



## Underfloor module

- Kitchen area consists of 2 modules
- Frame construction makes kitchenette construction possible
- 4 drawers, with the possibility of configuring the height of each drawer
- Worktop with possibility of installing kitchen units (induction hob, sink etc.)
- Shelving above kitchen worktop with aluminium-hinged lid
- Module remains identical to any lower shelter development



## PREFABRICATED CONCRETE SYSTEMS

**BEWA beton** Sp. z o.o.  
Wiechlice, ul. Przemysłowa 16  
67-300 Szprotawa, Poland

tel. +48 68 376 77 33  
[bewa@bewa.com.pl](mailto:bewa@bewa.com.pl)  
[www.bewa.com.pl](http://www.bewa.com.pl)

